

# Inventions

A Reading A-Z Level R Leveled Book

Word Count: 1,184

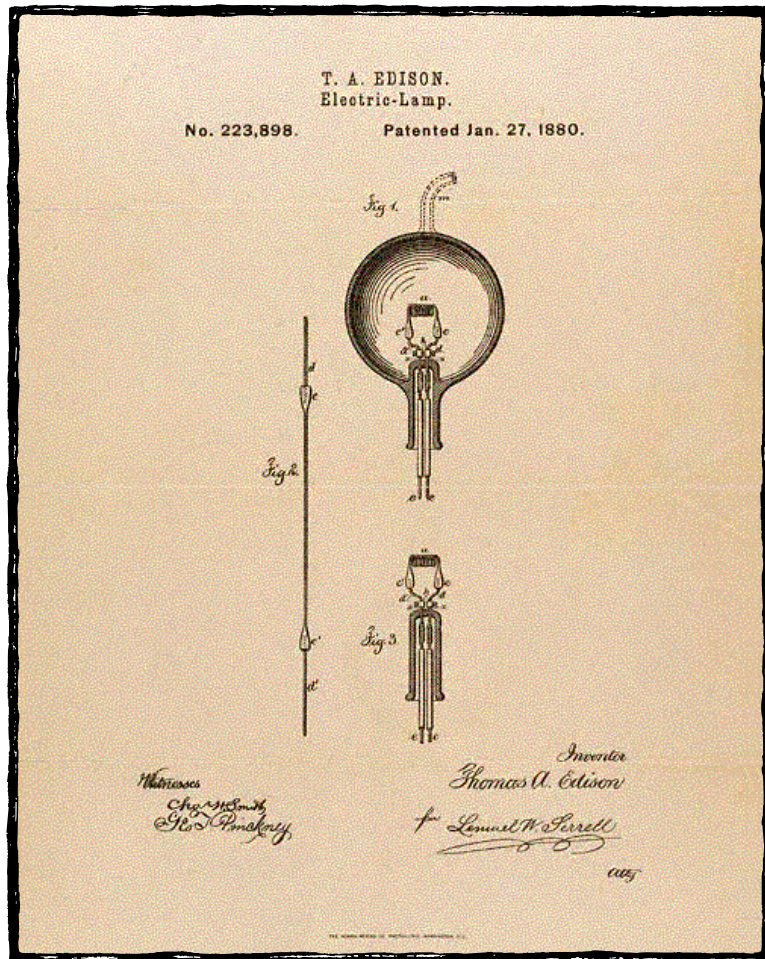

**Reading a-z**

Visit [www.readinga-z.com](http://www.readinga-z.com)  
for thousands of books and materials.

LEVELED BOOK • R

# Inventions



Written by Ned Jensen

[www.readinga-z.com](http://www.readinga-z.com)

# Inventions



Written by Ned Jensen

[www.readinga-z.com](http://www.readinga-z.com)

**Photo Credits:**

Front cover, title page (all), pages 3, 4, 7 (all), 8 (bottom), 10, 12 (all), 13 (light bulb), 16, 18: © Jupiterimages Corporation; back cover, page 11: courtesy of National Archives and Records Administration; page 5 (all): courtesy of United States Patent and Trademark Office; page 6: courtesy of Library of Congress, Prints & Photographs Division [LC-DIG-prok-02297]; page 8 (top): courtesy of Library of Congress, Prints & Photographs Division [LC-DIG-ggbain-02174]; page 9: courtesy of NASA, Kennedy Center Media Archive Collection; page 13 (telephone): © Sheila Terry/Photo Researchers, Inc.; page 13 (airplane): courtesy of Library of Congress, Prints & Photographs Division, [LC-USZ62-107026]; pages 13 (automobile, color television, microwave), 15: © Bettman/Corbis; page 13 (refrigerator): © Hemera Technologies/Jupiterimages Corporation; page 13 (television): © Lawrence Manning/Corbis; pages 13 (computer), 17 (top left): © Frederick News-Post/AP Images; page 14: © University of Manchester/AP Images; page 17 (bottom left): courtesy of the Computer History Museum; page 17 (top right): © Learning A-Z; page 17 (center right): © Julie Stupsker/AP Images; page 17 (bottom right): © STOCKFOLIO®/Alamy Images; page 19: © Salvatore Di Nolfi/Keystone/AP Images

Inventions  
 Level R Leveled Book  
 © Learning A-Z  
 Written by Ned Jensen

All rights reserved.

[www.readinga-z.com](http://www.readinga-z.com)

**Correlation**

| <b>LEVEL R</b>    |    |
|-------------------|----|
| Fountas & Pinnell | N  |
| Reading Recovery  | 30 |
| DRA               | 30 |



## Table of Contents

|   |    |
|---|----|
| Introduction .....                      | 4  |
| Inventions Follow Inventions.....       | 6  |
| Need Is the Mother of Invention .....   | 9  |
| Famous Inventions.....                  | 12 |
| Computers: Then and Now .....           | 14 |
| Invention, Discovery, or Creation ..... | 18 |
| Conclusion .....                        | 19 |
| Glossary.....                           | 20 |
| Index .....                             | 20 |

## Introduction

When you think of an **invention**, what comes to mind? Is it something wacky or something useful? Every day, people all over the world come up with new inventions. These inventions often give us a better way to do something. Most inventions make life easier or more enjoyable.

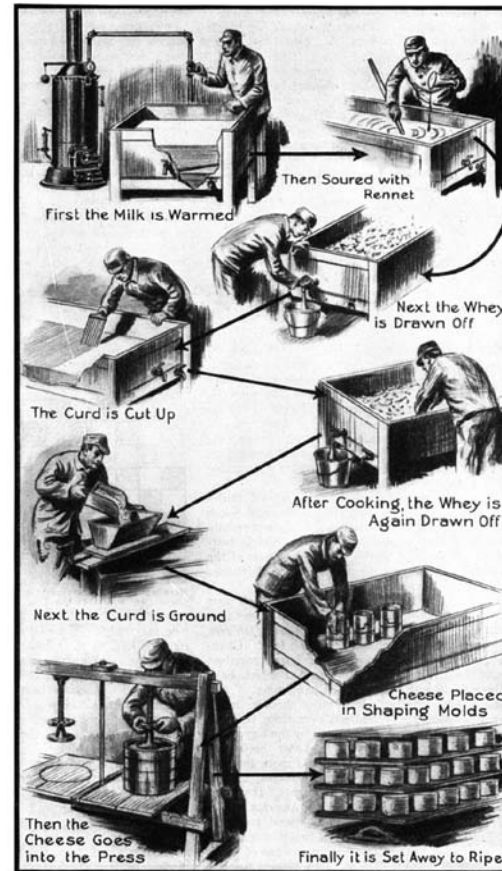

An invention isn't always a thing. An invention can also be a **process**. Examples of processes are ways of making certain metals or glass, or even kinds of cheese.

This shows a nine-step process common for making cheese.

## Weird Inventions

These are actual patent drawings of weird inventions.

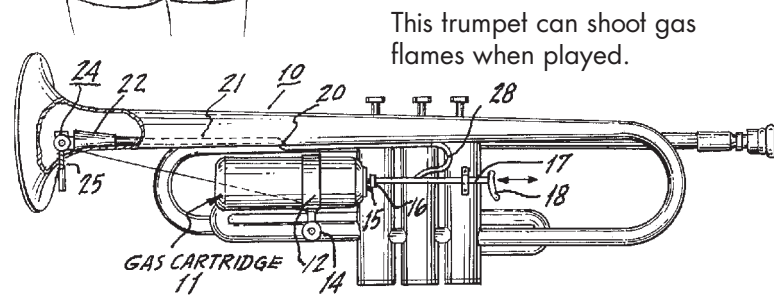
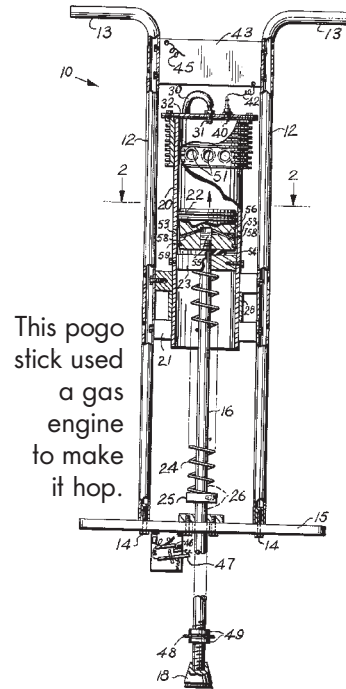
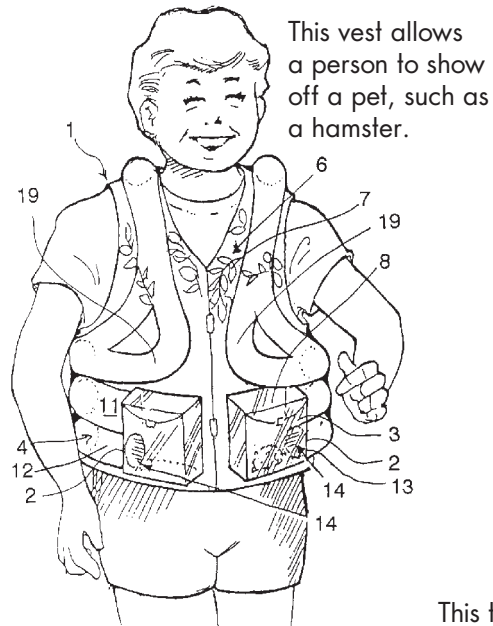

Not every invention is useful. Over the years there have been many weird inventions. All of these inventions were made to fulfill a need or a want. But many of these weird inventions either didn't work, or caused more trouble than good.



## Inventions Follow Inventions

One invention often leads to another invention. For an example, let's look at the wheel. Long ago, the only way people could get from place to place was to walk. It could take days to walk long distances. Then, someone invented the wheel.



Next, people started putting wheels on logs and boards. These simple carts made it easier to carry goods and people over long distances. Then people started using horses, oxen, or mules to pull the carts. Riding on carts was less work than walking and made it easier for travel.

In the 1800s, the gasoline **engine** was invented. The engine could be placed on carts and used to power them. Mules, horses, and oxen were not needed as much.

Engines have led to the invention of many other things that help move people and goods from place to place. Some of these inventions are steamboats, cars, trains, and airplanes. These inventions helped people and goods cross whole continents in just a few days.

### Think About It

The car has changed the lives of people around the world. It has led to many other inventions. How many things can you think of that were invented because of the car? Here are just a few to get you started. How many more can you add to the list?



- Traffic lights
- Gas pumps
- Expressways
- Car washes
- Drive-thru restaurants



Over time, more inventions made engines better. Today, jet engines help planes fly all over the world very quickly.

The jet engine, and humans' desire to fly higher and faster, led to the invention of a more powerful engine called the rocket engine. The rocket engine helps send people into space and to the Moon. It took many steps and many years of inventing to get people from the first airplane to the spacecraft that took humans to the Moon.

### History of Transportation

|                      |   |   |
|----------------------|---|---|
| <b>About 3500 BC</b> | first wheeled carts                               |   |
| <b>About 2000 BC</b> | horses first used to pull carts                   |   |
| <b>1662</b>          | first horse-drawn public bus                      |   |
| <b>1783</b>          | first practical steamboat                         |   |
| <b>1801</b>          | first steam-powered train                         |  |
| <b>1885</b>          | Karl Benz builds practical gasoline-powered car   |   |
| <b>1903</b>          | Wright Brothers fly first airplane with an engine |   |
| <b>1926</b>          | first rocket launched                             |   |
| <b>1947</b>          | supersonic jet flight                             |   |
| <b>1969</b>          | mission to the Moon                               |   |
| <b>1970</b>          | first jumbo jet                                   |   |
| <b>1981</b>          | space shuttle launched                            |   |

## Need Is the Mother of Invention

Sometimes when people want to explore new places, such as the Moon, or new things, such as stars, they need new inventions. It has been said that “need is the mother of invention.” This means that a need for something forces people to invent ways to solve that problem. New inventions can make exploration possible or easier.

People wanted to explore space. Space is different from Earth. Space has no air, which means there is no oxygen and no air pressure. Space is also very cold. People would not be safe in space without the right equipment.

The *New Horizons* spacecraft lifts off for its trip to Pluto.



## Space Exploration Product Spin-offs

- Enriched baby food
- Better golf balls
- Faster swimsuits
- Water purifiers
- Improved food packaging
- Shock-absorbing helmets
- Shock-absorbing shoes
- Smoke detectors
- Self-adjusting sunglasses
- Flat-panel televisions
- High-density batteries
- Trash compactors

The backpack this astronaut wears makes moving in space easier.



Scientists needed to invent ways for people to breathe in places where there was no air. They needed to invent new materials to keep both humans and spacecraft safe from extreme temperatures. Scientists invented spacesuits and building materials that would not crush under pressure. In fact, many new **products** were invented because people wanted to explore space.

When people invent something, they usually apply for a **patent**. A patent ensures that only the person who owns the patent can make or sell the invention. If you have a patent, no one else can take your idea. Complicated products, like cars, may have hundreds of patents for the thousands of parts used to make them.

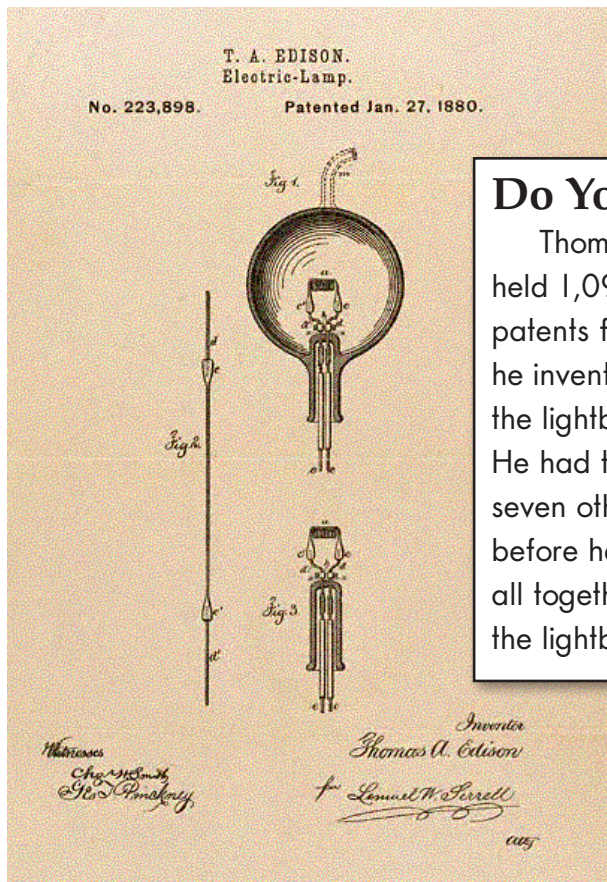

### Do You Know?

Thomas Edison held 1,093 different patents for the things he invented, including the lightbulb, left. He had to invent seven other things before he could put it all together to invent the lightbulb.

## Famous Inventions

There have been millions of inventions over the years. Some of them, like the invention of the lightbulb, are well known. However, others are obscure.

Most inventions get better over time. For example, Thomas Edison's first lightbulb, invented in 1879, has had many improvements since then. Think about how each invention in the timeline on the next page has changed and has been made better over the years. What would your life be like without these inventions?

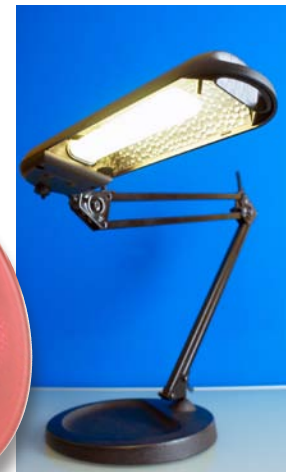

## Most Famous Inventions

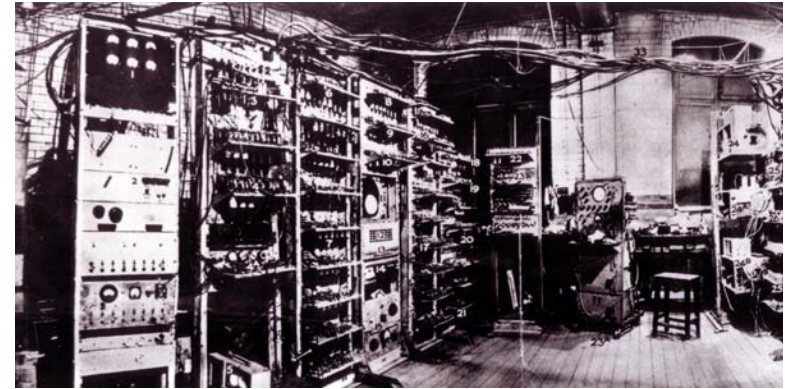
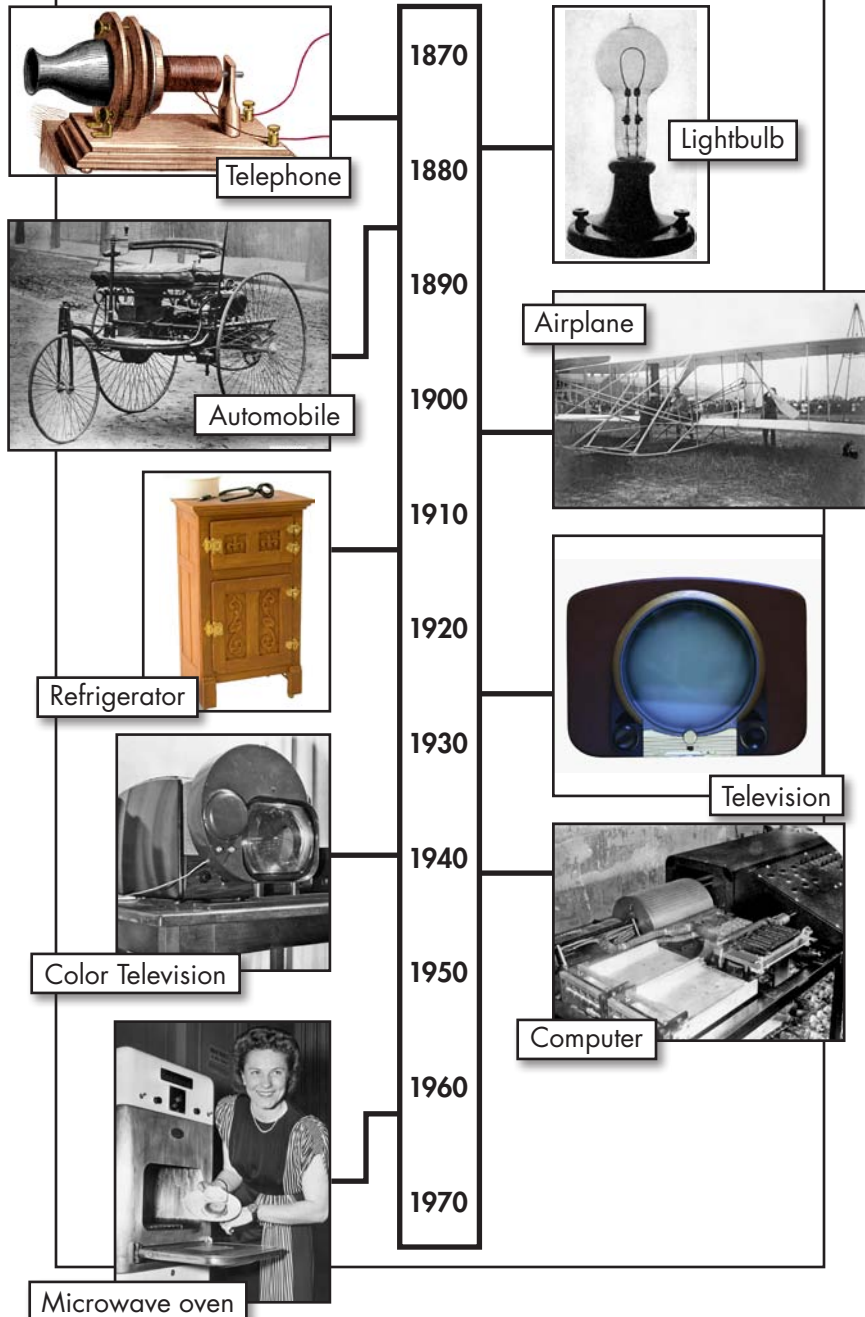

This early computer was jokingly named "Baby."

## Computers: Then and Now

Of all the inventions of the last fifty years, none has changed our lives more than the computer. The computer is a machine that has many parts. Many people have helped make the computer what it is today.

Many historians think that a German named Konrad Zuse invented the computer. In 1941, he used old materials to build the first computer. It could be **programmed**. It was used to do difficult math problems.

### Do You Know?

One of the first megacomputers could do one math operation every 15 seconds. Modern computers can do 150,000,000,000 operations in 15 seconds!



Later, two professors from Iowa State University in the United States invented a more powerful computer. It was the first electronic **digital** computer. It was the size of a desk. It had more than 300 glass tubes and used one mile of wire. It weighed 700 pounds. That is 140 bags of flour!

In 1944, two inventors worked together to build an even bigger and better computer. It was 55 feet long and 8 feet high. It filled a giant room and weighed 5 tons, or about as much as one elephant. It used lots of energy and needed a way to help keep it cool.



Harvard – IBM MARK I

In 1947, the **transistor** was invented. This meant that computers would no longer need hundreds of large glass tubes, and smaller computers could be built. The invention of **integrated circuits** then took the jobs of many electronic parts and put them into one part. Then **microprocessors** were invented, which took lots and lots of integrated circuits and put them into one microchip. These improvements led to the computers we use today.

But computers still needed other inventions. People needed to invent **software** to make the computer do different things. Also, people wanted thinner screens and mice that were



easier to use. Even more inventions came as people discovered new things to do with the computer.

A computer, a mouse, and software allow this boy to draw using a laptop.

Computers paved the way for the Internet, a whole new way of communicating. Webpages, electronic mail, and high-speed Internet connections soon followed. These things made communicating with people all over the world easy. What might computers do in the future? What will be invented then?

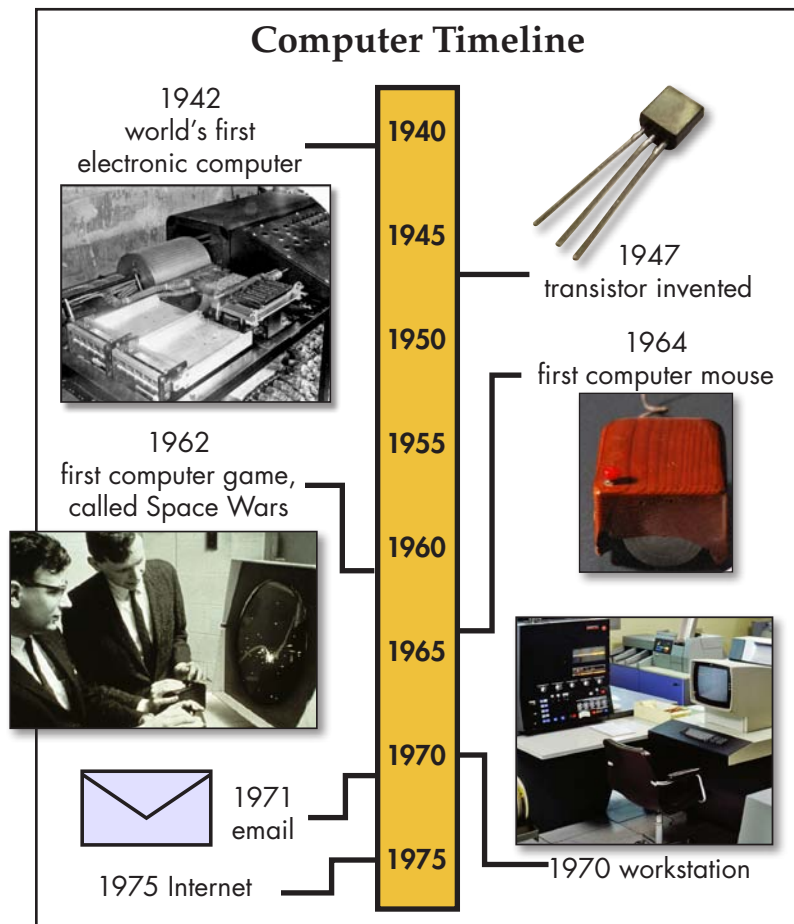

## Invention, Discovery, or Creation?

Have you ever wondered how an invention is different from a discovery or a creation? Discoveries are made when people first learn about things that already exist. For example, explorers are people who discover new lands.



Van Gogh's self-portrait

Creators are artists, composers, and writers. They make works of art, music, and stories. Vincent Van Gogh was an artist who created fantastic paintings. Beethoven was a composer who created beautiful symphonies. William Shakespeare was a writer who created great plays.

**Inventors** use existing knowledge to create new devices or processes. They make things that they think make life better or work easier. Thomas Edison used what scientists already knew about electricity to invent the lightbulb. He went on to invent many more things, such as the first movie projector.

## Conclusion

You might think that all the good things have been invented and that there is little left to invent. But that is not true. There is always a need to make things better. With each new invention, creation, and exploration, another is sure to follow. Maybe you will be the person who will invent the next product to make life easier or more exciting for us all!



An inventor demonstrates a new device for picking up Ping-Pong balls.

## Glossary

|  |  |
|--|--|
| <b>digital</b> ( <i>adj.</i> )           | relating to storing information as numbers (p. 15)                               |
| <b>engine</b> ( <i>n.</i> )              | a machine that uses energy to create movement (p. 7)                             |
| <b>integrated circuits</b> ( <i>n.</i> ) | tiny electronic parts that make a computer work (p. 16)                          |
| <b>invention</b> ( <i>n.</i> )           | a new device or process (p. 4)   |
| <b>inventors</b> ( <i>n.</i> )           | creators of a new device or process (p. 18)                                      |
| <b>micro-processors</b> ( <i>n.</i> )    | tiny chips that contain many integrated circuits (p. 16)                         |
| <b>patent</b> ( <i>n.</i> )              | legal rights to an invention (p. 11)   |
| <b>process</b> ( <i>n.</i> )             | a series of actions (p. 4)   |
| <b>products</b> ( <i>n.</i> )            | items or objects (p. 10)   |
| <b>programmed</b> ( <i>v.</i> )          | told how to do actions using computer code (p. 14)                               |
| <b>software</b> ( <i>n.</i> )            | computer programs (p. 16)  |
| <b>transistor</b> ( <i>n.</i> )          | a small device that controls the flow of electricity in electronic items (p. 16) |

## Index

|                        |                    |
|------------------------|--------------------|
| automobile, 7, 13      | Internet, 17       |
| Benz, Karl, 8          | lightbulb, 11      |
| carts, 6, 7            | patent, 11         |
| computers, 14–17       | processes, 4       |
| Edison, Thomas, 11, 18 | transistor, 16, 17 |
| exploration, 9, 10, 19 | wheel, 6, 8        |
| engines                | Wright Brothers, 8 |
| gasoline, 7            | Zuse, Konrad, 14   |
| jet, 8                 |                    |
| rocket, 8              |                    |